

Sizes in millimeters
Dimensions en millimètres

I.D. = inside dimension
O.D. = outside dimension
D.I. = dimension intérieure
D.E. = dimension extérieure

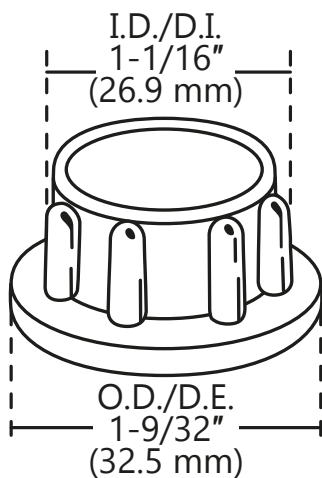

REFERENCE: F22949, V22949

