

Sizes in millimeters
Dimensions en millimètres

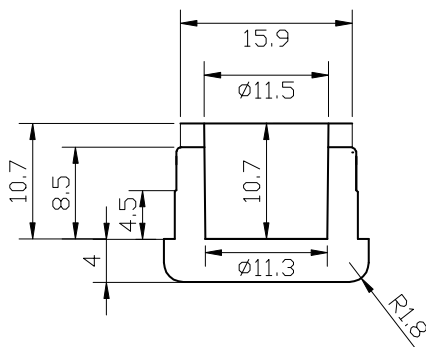

REFERENCE: F32064, F45402

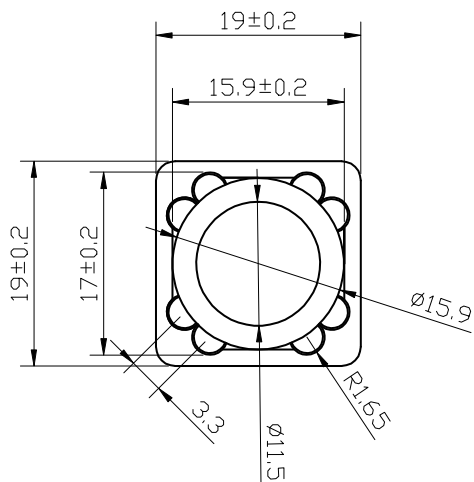