

Sizes in millimeters
Dimensions en millimètres

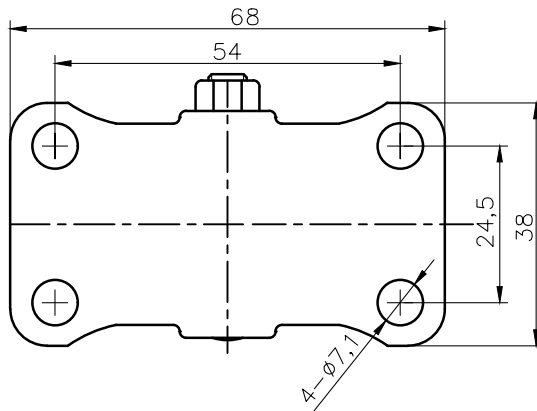

REFERENCE: F24822

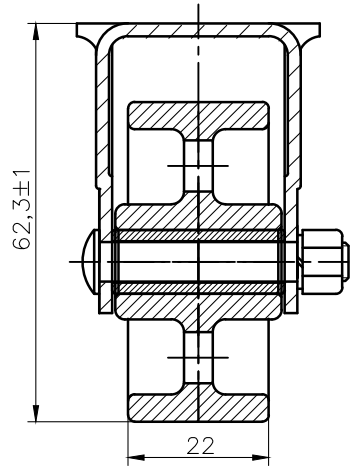
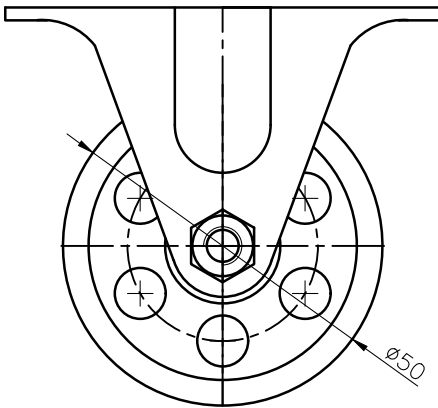